

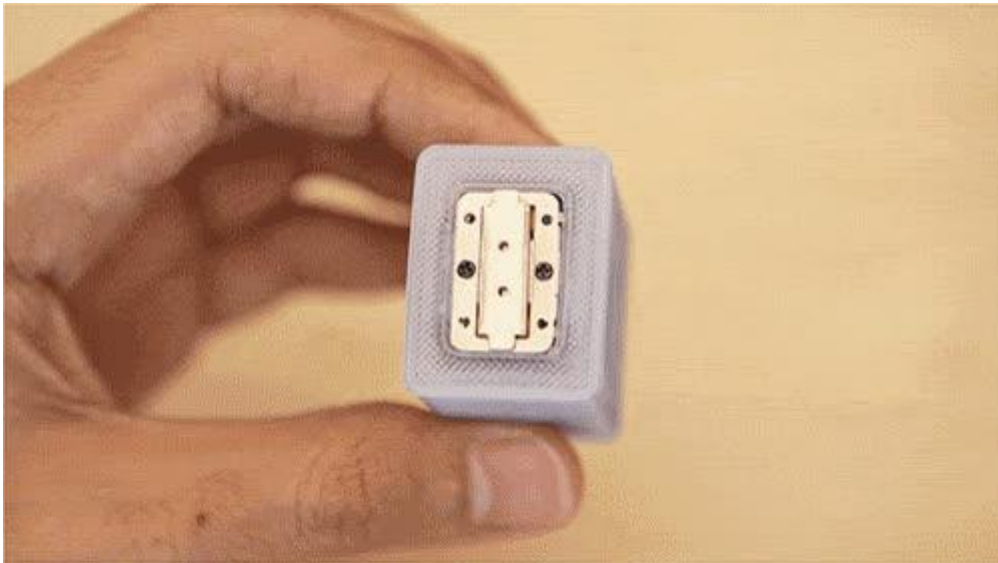

# 3D Printed Bone Conduction Transducer Box

Created by Ruiz Brothers



<https://learn.adafruit.com/3d-printed-bone-conduction-transducer-box>

Last updated on 2021-11-15 06:10:56 PM EST

# Table of Contents

Overview	3
• Tools & Supplies	4
• Parts	4
3D Printing	4
Circuit Diagram	5
• Stereo Jack	5
• Slide Switch Adapter	6
• Bone Conductor	6
Assembly	7
• Stereo Headphone Jack	7
• Slide Switch Adapter	7
• Bone Conductor	8
• Amplifier + Lipo Battery	9
• Closing it up	10
Usage	11

---

# Overview

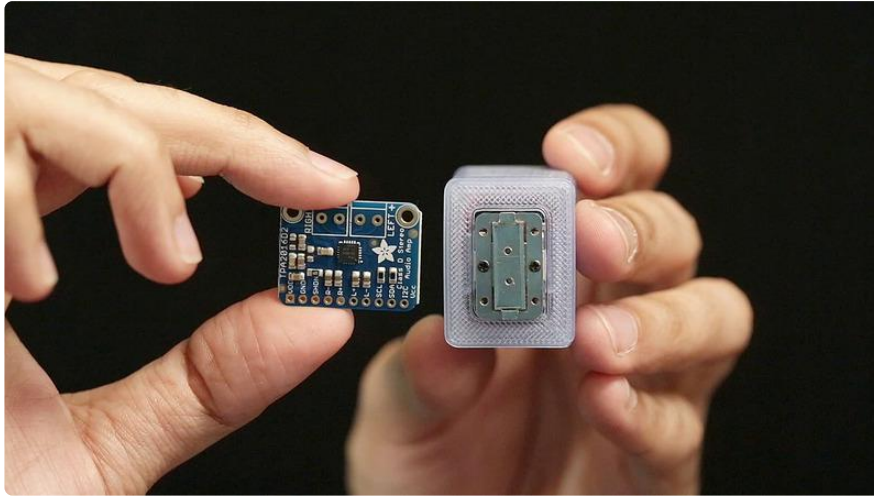

If your next project needs some sound, a bone conductor transducer will have you experimenting with all sorts of objects. If you've ever wired a speaker system before, you'll find this DIY electronics project is fun and easy!

This incredible speaker does not have a moving cone like most speakers you've seen, instead, a small metal rod is wrapped with the voice coil. When current is pulsed through the coil, the magnetic field causes a piece of metal to expand and contract - if pressed against a flat surface or cavity it turns it into a speaker!

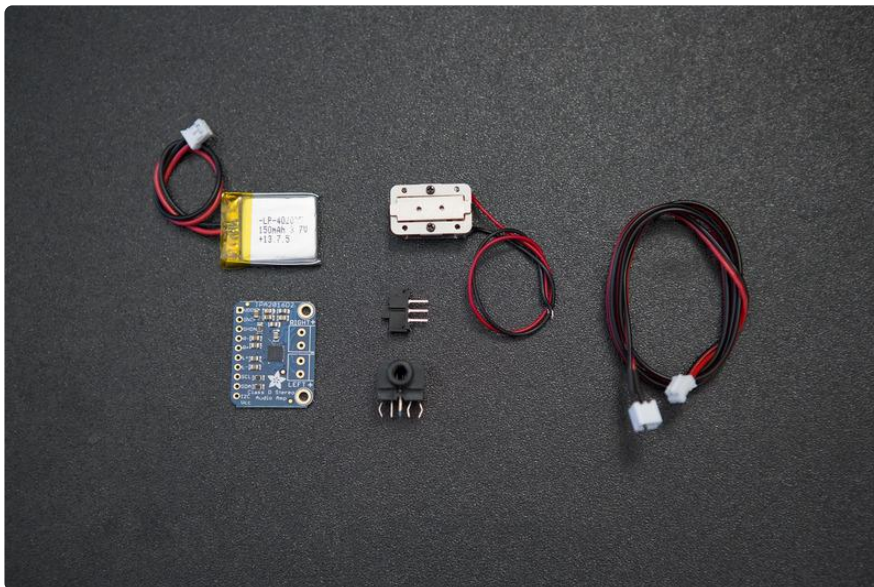

## Tools & Supplies

- [Soldering Iron](http://adafru.it/180) (<http://adafru.it/180>)
- [Wire Strippers](http://adafru.it/527) (<http://adafru.it/527>)
- [3D Printer](https://adafru.it/d9z) (<https://adafru.it/d9z>)

## Parts

- Amplifier board - we suggest the [MAX98306](http://adafru.it/987) (<http://adafru.it/987>) or [TS2012](http://adafru.it/1552) (<http://adafru.it/1552>)
- [Bone Conductor Transducer](http://adafru.it/1674) (<http://adafru.it/1674>)
- [150mAh Lithium Ion Polymer Battery](http://adafru.it/1317) (<http://adafru.it/1317>)
- [Stereo Headphone Jack](http://adafru.it/1699) (<http://adafru.it/1699>)
- [Slide Switch](http://adafru.it/805) (<http://adafru.it/805>)
- [JST Battery Ext. Cable](http://adafru.it/1131) (<http://adafru.it/1131>)

---

## 3D Printing

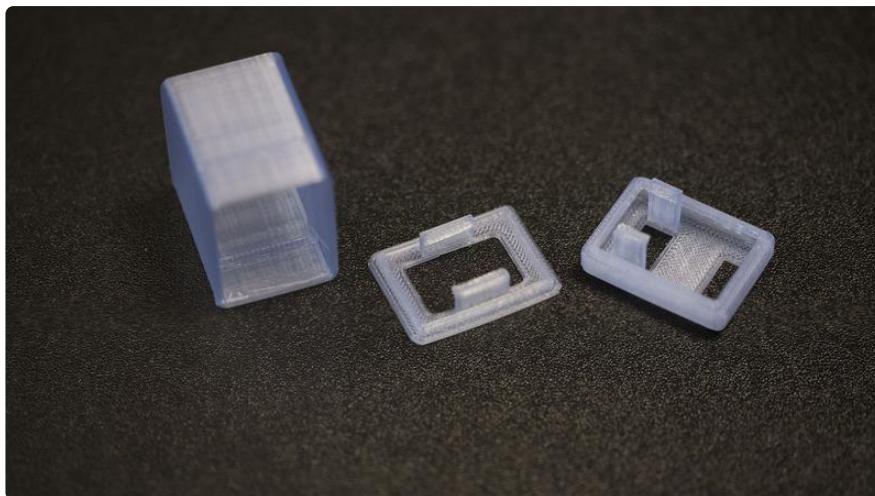

Download STLs

<https://adafru.it/dcK>

bonebox-bottom.stl	PLA @230	Takes about 1.5 hours to print all pieces
bonebox-top.stl	No Raft/Support	
bonebox-case.stl	%15 infill	
	2 shells	
	0.2 layer height	

The enclosure is a three piece design that snap-fit together. The [bonebox-top.stl](https://adafru.it/dcL) (<https://adafru.it/dcL>) part houses the slide switch and audio input jack. The [bonebox-case.stl](https://adafru.it/dcM) (<https://adafru.it/dcM>) part houses the amplifier and lithium polymer battery. The [bonebox-bottom.stl](https://adafru.it/dcN) (<https://adafru.it/dcN>) part houses the bone conductor transducer exposing the vibrating metal piece but is secured in place with built in clips on the bottom part.

The parts are optimized to slice with MakerWare and printed using PLA with no raft or support material.

## Circuit Diagram

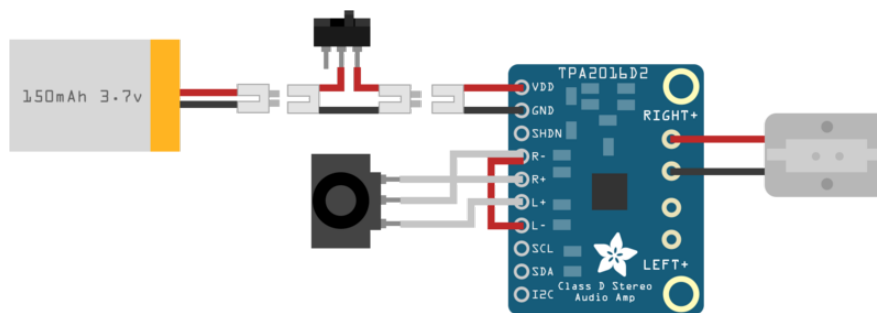

Follow the circuit diagram above to connect the components. If your new to electronics, use a bread-board to prototype the circuit before soldering any connections.

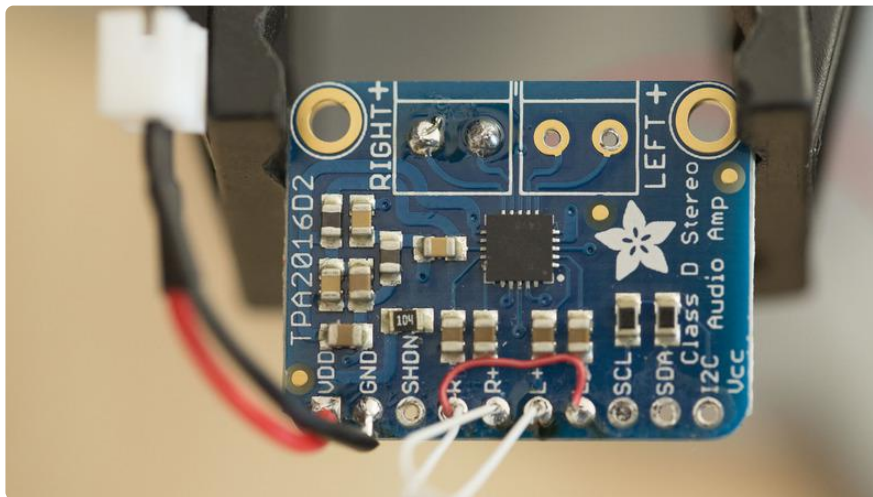

## Stereo Jack

Connect the most far left and right terminals to the R+ and L+ pins on the TPA2016. The middle terminal will connect to the R- pin. You will need to jump the R- and L- pins with a separate wire. We aren't using both channels, so you can also tie R+ and L+ together to make a basic 'stereo mix'

## Slide Switch Adapter

Use a JST extension cable to create a slide switch adapter. The positive cable will split a connection to the two terminals of the slide switch. You will need to shorten the length of the JST extensions as short as possible. To avoid soldering the JST extension that is connected to the switch, use another JST extension to solder into VDD and GND pins.

## Bone Conductor

The bone conductor transducer can be soldered to either the right or left audio channels.

Please note: Bone conductor transducer wires are soldered from the bottom of the amplifier for positioning the circuit into the 3d printed enclosure.

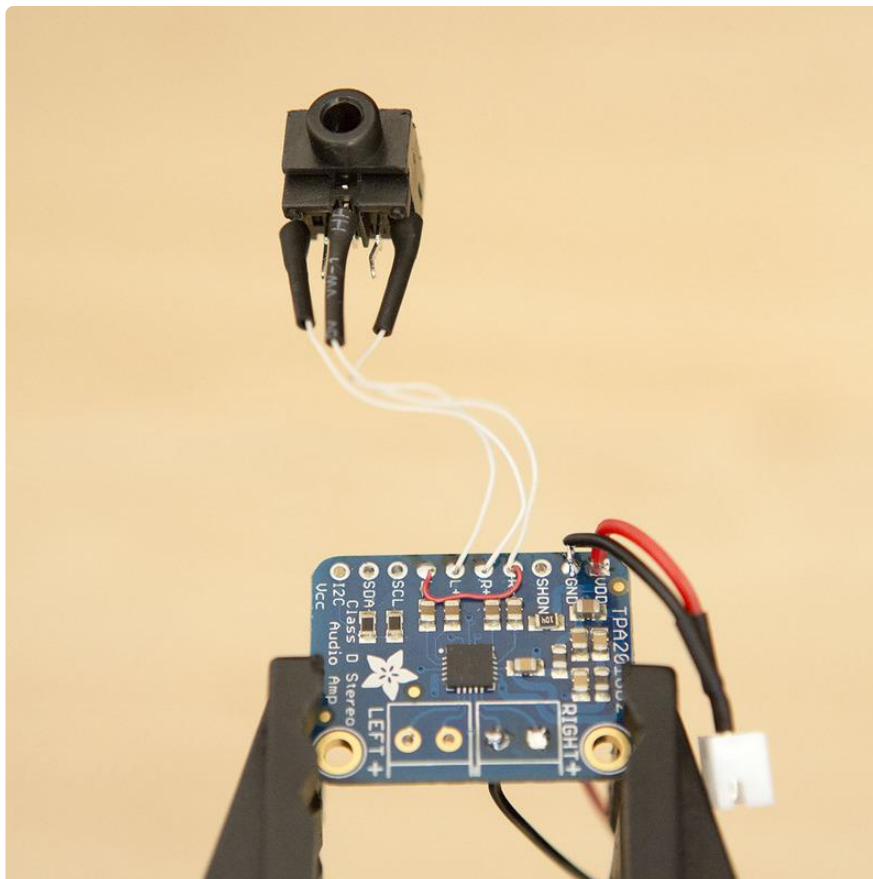

---

## Assembly

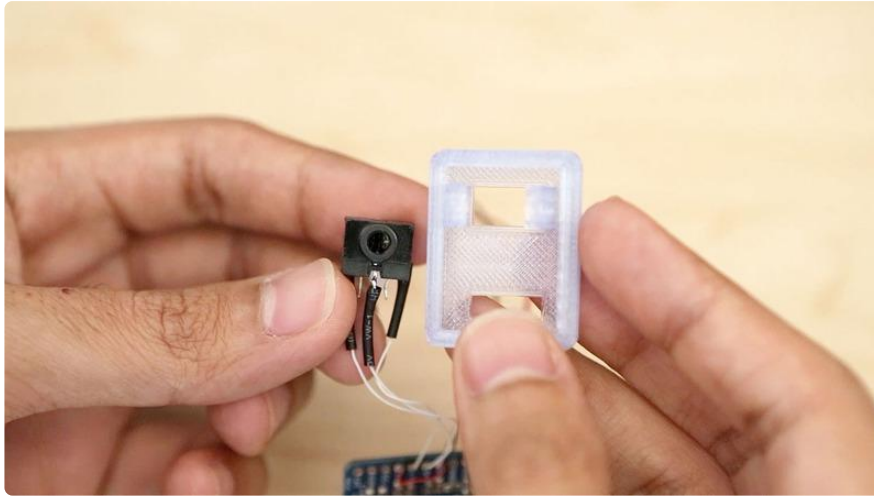

### Stereo Headphone Jack

Start by placing the audio input jack into the [bonebox-top.stl](https://adafru.it/dcL) (<https://adafru.it/dcL>) part by lightly pushing apart the clips and pushing the input jack into the opening. The jack should snap into place with the tips of the clip holding the input jack in place.

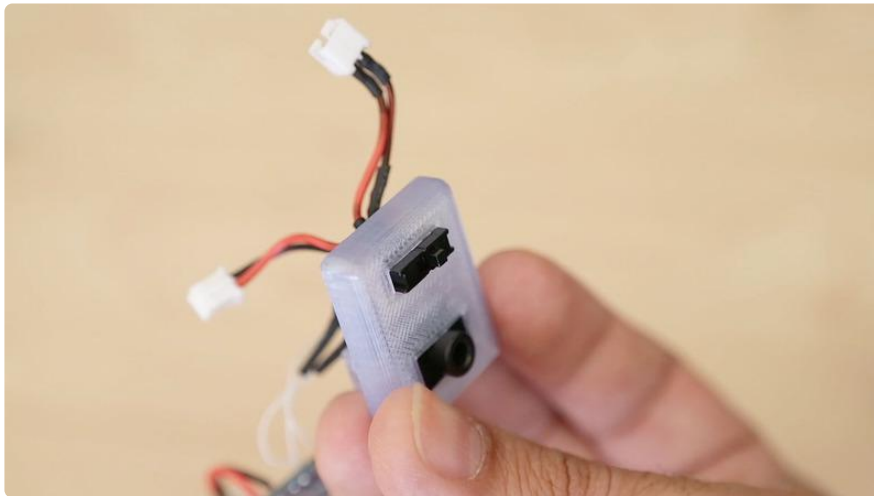

### Slide Switch Adapter

The slide switch is pressed into the bonebox-top.stl part by pushing it into the opening. Once it's secured, set it aside.

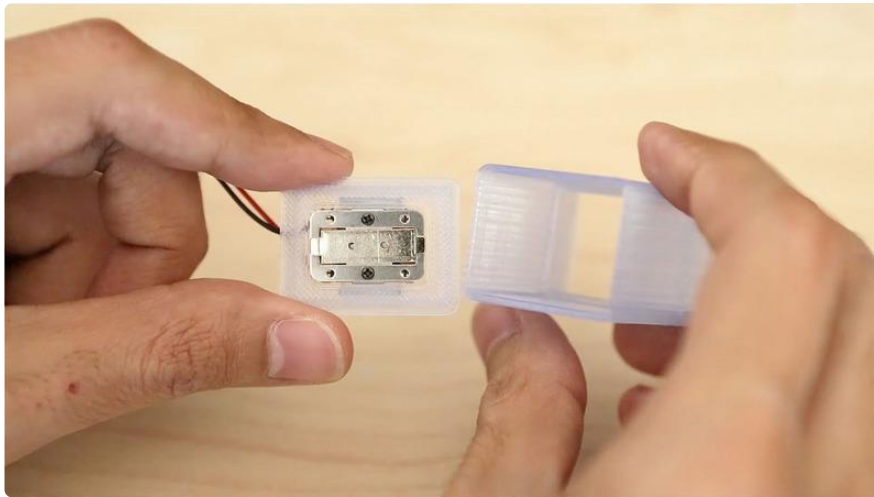

## Bone Conductor

The bone conductor transducer is secured to the [bonebox-bottom.stl](https://adafru.it/dcN) (<https://adafru.it/dcN>) part with clips built into the part, similar to the bonebox-top.stl part. The metal plate is exposed so that it can transfer audio more efficiently.

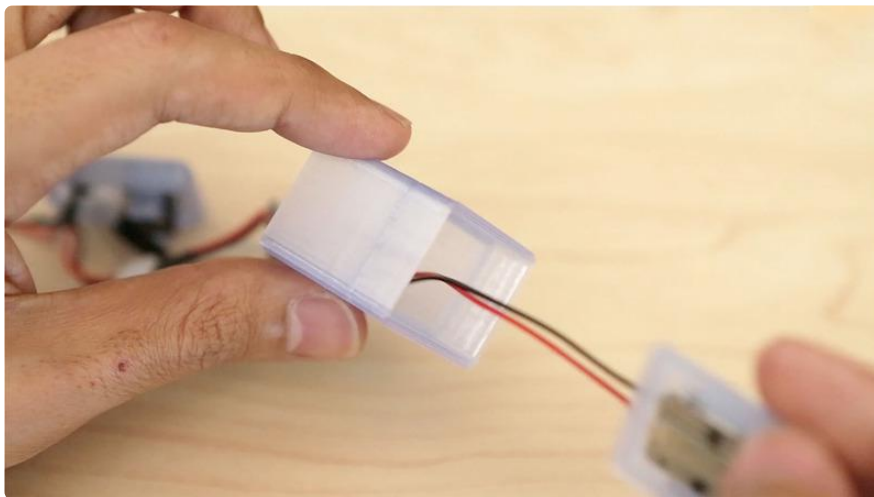

Pull the bone conductor transducer and bonebox-bottom.stl part through the bonebox-case.stl part with the inner lip positioned towards the bottom.





Gently arrange the wires of the battery and slide switch adapter into the bonebox-case.stl part and snap the bonebox-top.stl piece into place.

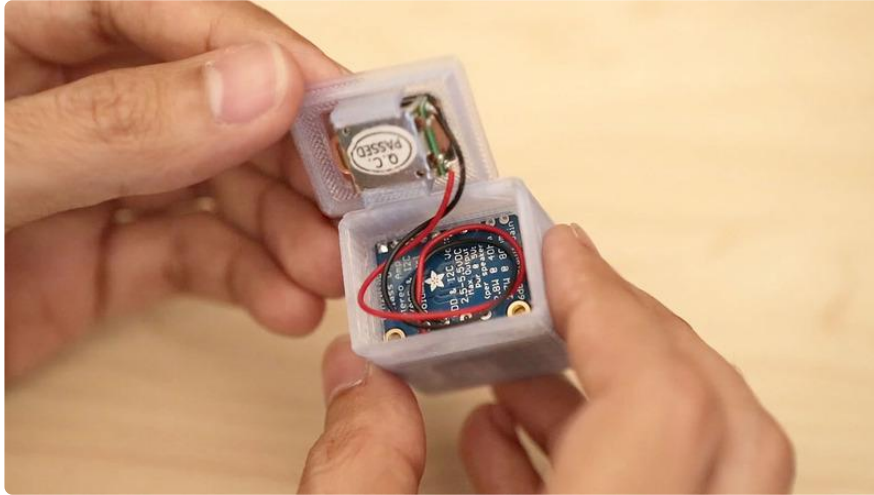

## Closing it up

Coil up the excess wiring of the bone conductor transducer and press fit the bonebox-bottom.stl into the bonebox-case.stl part. Now your bone conductor transducer is packaged up and ready to turn surfaces into speakers!

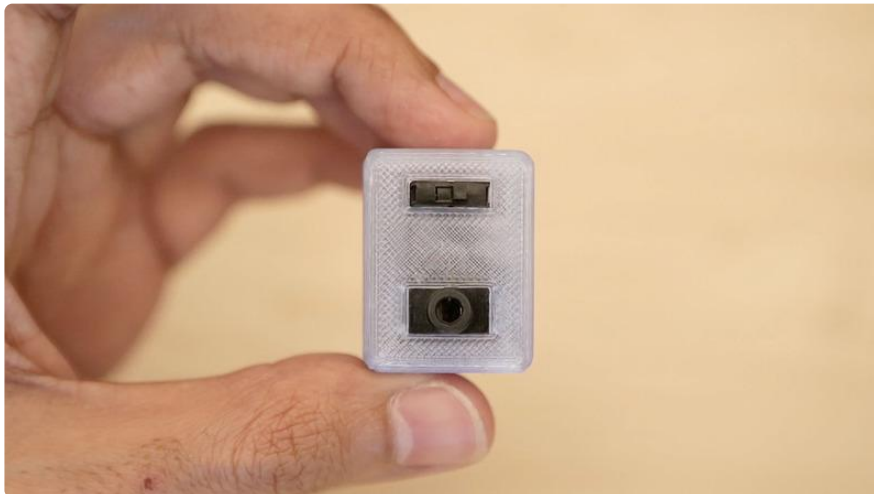

---

## Usage

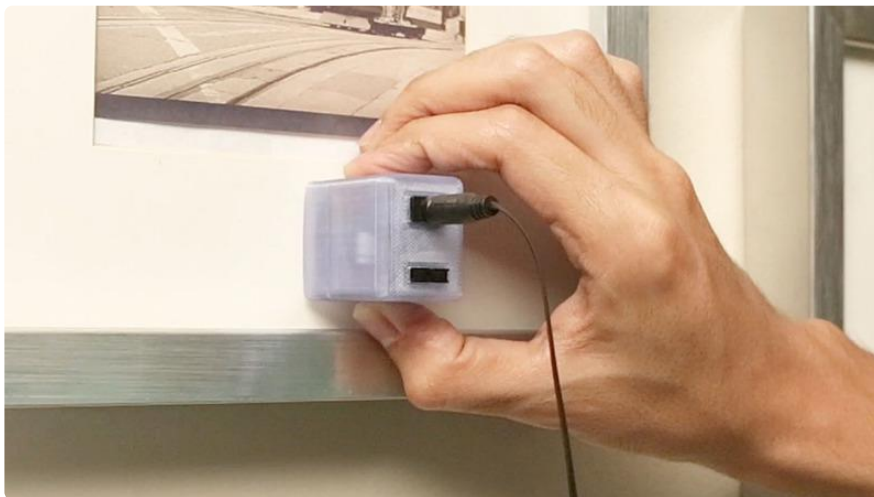
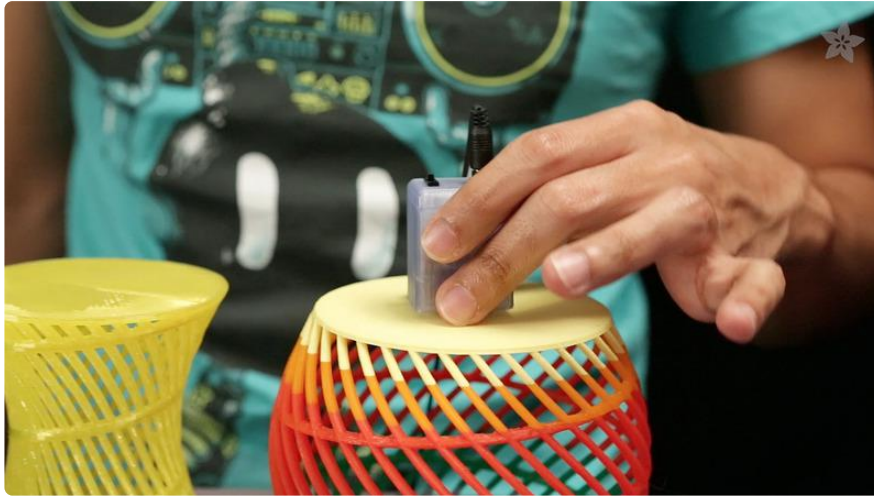

Works on several different surfaces! Objects that are hollow perform much better than objects that are more dense. Below is a list of materials that it seems to work well with.

- Acrylic
- Wood
- Plastic
- Glass

The bone conductor transducer produces that best quality sound when it's pressed up against a surface. If the bone conductor box is loosely placed on a surface, it will cause the metal plate to vibrate the surface too much and cause clippy audio.